



THE PNW 4-H HORSE CONTEST GUIDE

A Pacific Northwest Extension Publication
Oregon State University • Washington State University • University of Idaho

PNW 574

Effective October 1, 2015

THE PNW 4-H HORSE CONTEST GUIDE

Revised by the PNW 4-H Horse Management Team

Oregon members are Roberta Lundeberg, Oregon State University 4-H State Program Coordinator; Peggy Ashford, PNW Judges' List Coordinator; and Candi Bothum, OSU Extension Deschutes County Program Coordinator.

Washington members are Jennifer Leach, Washington State University 4-H Equine Specialist; Doug Evenson, PNW Judge; Anne Garrett, PNW Judge; and Pat Pehling, 4-H volunteer.

Idaho members are Valdasue Steele, Extension Educator; and Jim Wilson, Area 4-H Youth Extension Educator; both of the University of Idaho.

Originally adapted (2005) from EB1974 by Candi Bothum, 4-H County Program Coordinator; Roberta Lundeberg, 4-H State Program Coordinator; Shirley Watson, 4-H Program Assistant (retired); and Peggy Ashford, 4-H volunteer, all of Oregon State University; and Jerry Newman, Extension 4-H Youth Development Specialist (retired); Marilyn Anderson, Anne Garrett, Doug Evenson, and Pat Pehling, all 4-H volunteers; all of Washington State University.

For corrections or changes to this publication, contact:

In Idaho—

University of Idaho, 4-H Youth Development

875 Perimeter Dr., MS 3015

Mary Forney Hall, Rm 206

Moscow, ID 83844-3015

Phone: 208-885-6321

FAX: 208-885-4637

<http://www.uidaho.edu/extension/4h/awardsscholarshipscontests/asc/statecontests>

In Oregon—

Oregon State University, 4-H Youth Development State Office

106 Ballard Extension Hall

Corvallis, OR 97331-3608

Phone: 541-737-4444

FAX: 541-737-0999

<http://oregon.4h.oregonstate.edu/>

In Washington—

Washington State University, 4-H Youth Development State Equine Advisory Committee

ATTN: Jennifer Leach, 4-H Equine Specialist

1946 3rd Ave.

Longview, WA 98632

Phone: 360-577-3014 ext. 4

FAX: 360-423-9986

<http://4h.wsu.edu>

Any corrections or changes must be sent to and approved by the appropriate horse development or equine advisory committee. Approved changes will be forwarded to the PNW 4-H Horse Management Team for review and final decision.

THE PNW 4-H HORSE CONTEST GUIDE

These contest rules are 4-H policy for Washington, Oregon, and Idaho 4-H Horse programs. 4-H events are provided for under the auspices of state land-grant universities. All members, leaders, parents, and judges should be aware of these rules when participating in 4-H activities, and it is expected that these rules will be observed.

This contest guide contains general rules and guidelines for competitive activities in the 4-H Horse program. Contests help youth measure progress in knowledge and skill in horsemanship. They also provide opportunities to learn social skills and have fun.

Counties are bound by state rules but may be more restrictive. Counties should create rules and criteria for “county only” classes not addressed in this guide. This makes it easier for leaders to teach and judges to evaluate a member’s performance.

Failure to abide by rules in the *4-H Horse Contest Guide* may result in dismissal from the show, forfeiture of all awards, or both. In addition, any gross abuse of these rules could result in the removal of a 4-H member from the 4-H program.

In addition to this guide and information provided by local show committees, there are several support publications available. 4-H members, leaders, and parents are strongly encouraged to read the following 4-H horse manuals **before** using this contest guide to better understand the terminology and context for the information provided here. Additional resources are listed below for those interested in related activities and opportunities. If any discrepancies exist between sources, **this contest guide takes precedence over all other material.**

PNW resources

- *4-H Driving Manual* (PNW 229)
- *4-H Hunt Seat and Jumper Manual* (PNW 488)
- *4-H Horse Judging Manual* (PNW 575)
- *The 4-H Horse Project* (PNW 587)
- *4-H Dressage Manual* (PNW 608)

Oregon resources

- E.L. “Dad” Potter 4-H Horsemanship Award (4-H 751-11)

Washington resources

- *Beginning Horsemanship* (EM4842E)

Idaho resources

- Idaho Horsemanship Award
<http://www.uidaho.edu/extension/4h/awardsscholarshipscontests/asc/stateawards>

Members who wish to participate in open or breed shows should check appropriate show rules for tack, dress, and performance requirements.

CONTENTS

Mission	5
General Rules	5
Show Protocol.....	6
Competition Divisions	6
Approaching the Judge.....	7
Drugging	7
Volunteer Policy on Animal Disease Diagnosis and Treatment	8
Project Animal.....	8
Possession.....	8
Replacement.....	9
Horseless Horse Project.....	9
Clothing and Equipment	9
The 4-H Equestrian Headgear Policy.....	9
Western	10
Hunt Seat and Dressage.....	12
Saddle Seat.....	13
Contest Guidelines	14
Show Classes	14
Class Priorities	14
Ribbons and Awards.....	14
Participation.....	15
Performance Guidelines	15
Showmanship.....	15
Equitation (Western, Hunt Seat, and Saddle Seat)	17
Dressage Seat Equitation.....	18
Bareback Equitation.....	18
Hunt Seat Equitation over Fences.....	18
Dressage.....	20
Western Dressage	20
Trail	20
In-hand Trail.....	20
Driving	23
Appointments	23
Driving Classes.....	25
The E.L. “Dad” Potter Award	29
Three-step Certificate of Merit.....	31
Washington State Medals Program	32
Idaho Horsemanship Award	32
Ground Training	33
Western Games	34
General Information.....	34
Scoring.....	34
Recommended Awards	34
General Rules.....	35
Approved Events.....	40

MISSION

As part of the 4-H Youth Development Program, our mission is to use the 4-H horse project as a vehicle for members to practice life skills while learning about the equine industry and how to safely handle, ride, and manage their horse.

4-H Motto:

To Make the Best Better

4-H Pledge:

I pledge my HEAD to clearer thinking,
My HEART to greater loyalty,
My HANDS to larger service,
And my HEALTH to better living
For my club, my community, my country, and my world.

GENERAL RULES

1. 4-H members participating in any 4-H equestrian activity must wear an approved helmet whenever they are mounted on an equine or are in a vehicle (cart, wagon, buggy, etc.) being pulled by an equine. An approved helmet meets the minimum performance standards imposed by the American Society for Testing Materials (ASTM) F1163 and includes certification and labeling required by the Safety Equipment Institute (SEI). The helmet must be properly fitted with the harness engaged and properly fastened according to manufacturer's instructions. It is recommended that 4-Hers wear their ASTM/SEI helmets any time they are around their horse.
2. Only 4-H members may ride, groom, school, or handle a horse while on the show grounds. Junior members may have assistance with saddling and bridling if needed. Anyone may have assistance for safety reasons.
3. No one is allowed to coach contestants while the contestants are in the show ring.
4. A horse not under control may be dismissed from the ring.
5. A visibly ill or unsound animal may be dismissed from participation by show personnel or at the judge's discretion.
6. Humane treatment of all animals is required. Exhibitors are expected to treat their animals with respect and provide for their continuous well-being through proper feeding, handling, disease prevention, sanitation, and attention to safety.
7. No one may ride a horse double at any time.
8. No one may ride a horse with a halter only.
9. The show arena is off-limits to everyone except working show personnel or during an emergency.
10. Judges' decisions are final.
11. Show management or the judge reserves the right to dismiss any youth or party from any 4-H class or show for any misconduct, lack of sportsmanship, or rule infraction. Exhibitors thus dismissed may forfeit all awards received in the class or at the show.
12. County committees may make accommodations for special circumstances at county 4-H events. State committees may decide if county accommodations are eligible for respective state 4-H events.
13. Silver will not be given preference by the judge.

14. Misrepresentation or falsification of a horse's age is grounds for an exhibitor's immediate disqualification from a 4-H event and subsequent disciplinary action by local Extension personnel, up to or including dismissal from the 4-H program.

Show Protocol

1. Members should be courteous and alert and follow instructions given by the judge or ring steward, including entering promptly when a class is called.
2. Contestant numbers must be clearly visible either on the rider's back or on both sides of the saddle pad. (The exhibitor is responsible for supplying the second number.)
3. If an exhibitor needs a "gate hold" (delay of class) for equipment change, he or she must request this before the class is called to enter into the arena. Delays may be penalized at the judge's discretion.
4. A red ribbon on the tail marks a horse that may kick if crowded.
5. Attitude is scored. Exhibitors should show confidence and pride in themselves and their animals. They should be good sports. Contestants are judged at all times when in the ring.
6. Equipment or class rules may be modified or exceptions may be made by show management at their discretion, as needed for safety of special needs youth or youth needing extra assistance.
7. Equitation classes are judged on the skill of the rider. The horse is not judged on conformation.
8. When a judge requests a movement to the right (off-side) or left (near-side), this is to the horse's right or left.
9. Exhibitors should not pat their horse while being judged in the ring, except during a colt or ground training class.

Competition Divisions

Idaho (ages as of January 1)

Junior: 8 to 11 years

Intermediate: 12 to 14 years

Senior: 15 to 18 years, or still in high school

Oregon (ages as of September 1)

Junior: 9 to 11 years

Intermediate: 12 to 14 years

Senior: 15 to 19 years (and still in high school)

Washington

Youth in the 3rd grade who have reached their 8th birthday by January 1 of the current 4-H year are eligible to enroll.

Junior: 3rd, 4th, and 5th grades

Intermediate: 6th, 7th, and 8th grades

Senior: 9th, 10th, 11th, and 12th grades

Youth who have reached their 19th birthday before January 1 of the current 4-H year are no longer eligible for membership. For further clarification on age and grade requirements for competition, refer to the Washington State 4-H Program Policy publication (EM0758E).

Inter-age competition statement

Washington State does not allow inter-age competition. For example, juniors may not compete against intermediates, or intermediates against seniors.

Approaching the Judge

Exhibitor

While the judge's decision is final, every exhibitor should have an opportunity to approach the judge to ask questions. This should be for educational purposes, not to dispute placings. The exhibitor should not approach the judge until after the final class of the day or as otherwise specified by the show committee. A parent or leader may be present. The contestant should provide their exhibitor number and any score sheets they may have received, but **photos or any visual recordings are not allowed**. The contestant should expect discussion or explanation on how to improve.

Show committee

It is the show committee's responsibility to provide an opportunity for exhibitors to approach judges. This information will be relayed to exhibitors during the informational meeting or by other means. Before the beginning of a class or show, questions about specific classes or rules must be addressed to ALL exhibitors, not one-to-one. Show committees need to remember that judges' decisions are final.

Judge

Each judge should confirm with the show committee or superintendent when questions may be asked and answered, and when an exhibitor may approach the judge. Since judges' decisions are final, they should expect their decisions to be upheld. A judge should be able to provide oral or written comments or clarification to an exhibitor when asked.

Judges must address questions about specific classes or rules to ALL exhibitors, not one-to-one.

Recourse

Judges' decisions are final. A show committee has the option to not rehire a judge who has not met their expectations. Concerns regarding PNW-qualified horse judges who do not meet 4-H standards can be addressed to the PNW Judges' List Coordinator and the PNW judges review committee. Evaluation forms are available on the web and at county Extension offices. The coordinator and committee will investigate any concerns and make an appropriate response to the judge.

Drugging

The 4-H Horse Program does not tolerate the use of illegal drugs and/or the improper use of animal health products or foreign substances. The administration of any drug or medication that affects the animal's conformation, appearance, natural performance, behavior, or in any way alters its natural color is unacceptable. Extension personnel, 4-H volunteers, families, youth, and show officials have a legal and moral obligation to not misuse these products and to report those that do. Consequences are at the county's discretion.

Horses that require any medication should be identified upon arrival at the 4-H Horse Show Office or registration area. Exhibitors should be prepared to present a valid prescription or a written explanation (or both) that is signed by the animal's licensed veterinarian. If a horse requires medication or treatment to protect its health and welfare after arrival at the show, the medication

must be prescribed by a licensed veterinarian. All medication, at all times, must be administered in accordance with the prescription specification or instructions (or both). The exhibitor's parent or legal guardian is responsible and liable for the correct administration of the prescribed drug.

Volunteer Policy on Animal Disease Diagnosis and Treatment

4-H volunteers, as representatives of a land-grant university, are expected to act within the policies and guidelines of the 4-H Youth Development Program. A 4-H animal science volunteer may educate members and their families in the normal course of their 4-H activities in the areas of animal care, production, and management. University volunteers are NOT to engage in activities that include diagnosis, treatment, or the direct administration of medication to protect animals without authorization from a licensed veterinarian. A 4-H volunteer may exercise commonly accepted first-aid skills and practices in emergency situations.

Project Animal

Each member is expected to have access to one or more horses that he or she may own, share, or lease.

A shared project animal is defined as one shared only by immediate family members or two non-family members, including both care and training responsibilities. Members and parents must recognize that they may need to make adjustments, choices, or both to adapt to show conditions or schedules, such as when two members sharing a horse are in the same class or are competing for championships.

A lease agreement is permitted if the member provides primary care for the horse. States or counties may require that a copy of the lease be included in the member's record book.

The horse shown in a 4-H exhibit activity must be the member's project horse. To participate at state fair, an exhibitor must use the same horse that was exhibited at the county fair. Stallions older than 12 months are NOT allowed in 4-H contests or events.

Horses should be clean and well-groomed, with the feet trimmed or shod. Fetlocks, muzzle, and bridle path should be trimmed according to breed type. Exhibitors may not decorate their horse with glitter, paint, or other means except in Western gaming or other specified county-only class.

To be classified as a pony, the animal must be 56 or less inches high. When there are a great number of ponies, they may be divided into small pony and large pony divisions:

Small pony: any pony less than 48 inches high

Large pony: any pony 48 to 56 inches high

When there are few ponies, counties have the option to combine horse and pony classes.

Possession

The goal of 4-H is to ensure that youth have opportunities within the four Essential Elements of the 4-H Youth Development Program (belonging, mastery, independence, and generosity). Projects are used as tools to promote positive youth development. The purpose of 4-H events is for 4-H members to demonstrate what they have accomplished with their projects during the year. The goals of the 4-H program are only met if the accomplishments demonstrated are the result of the 4-H member's own work. Therefore, project animals (owned, leased, or shared) must be under the care and management of the 4-H member at least 90 days before the animal may be shown at the official county exhibit activity.

Specific requirements for possession and training limitations may be found in each state's Exhibitor Handbook and/or state 4-H program policy publications.

Replacement

Counties have the option to use an appeal board or variance committee process to determine if an animal can be replaced in the case of death, severe injury, or unsafe behavior. A successful appeal may show at the county level but will not be allowed to exhibit at state fair.

Horseless Horse Project

A youth may choose to enroll in the Horseless Horse project. Primary members (grades K to 2 in **Washington**) or Cloverbuds (ages 5 to 8 in **Oregon**) may also enroll in the Horseless Horse project, but they may have NO contact with horses.

In **Idaho**, a “non-horse” project is available for interested youth who do not have access to a project animal.

CLOTHING AND EQUIPMENT

Members and attendants should be neat, clean, and dressed in long-sleeved shirts and long pants. Boots are required for exhibitors in all classes (attendants may wear hard-soled shoes). Boots are defined as high-topped (above the ankle) leather or leather-like riding shoes with heels. (The boot must have an adequate heel to prevent it from moving forward through the stirrup.) Exhibitors must be able to move the boot freely in the stirrup and easily slide the boot out of the stirrup.

Equipment must be safe, clean, properly adjusted, and suitable for the class being shown. Exhibitors with equipment that does not meet these standards may lose points or possibly be eliminated. Equipment age or cost is not considered.

An exhibitor's hair must be worn in a net, braid(s), or other means to present a neat appearance and give the judge a clear view of the show number.

Each member must have proper clothing and equipment for the specific classes entered (refer to the appropriate divisions below). Variations in clothing, tack, or both (including bandages on the horse) are permitted if there is a valid medical reason. However, a letter explaining the need for the variation, signed by the physician or veterinarian, must be presented to the show managers before the start of the show.

The 4-H Equestrian Headgear Policy

4-H members participating in any 4-H equestrian activity must wear an approved helmet whenever they are mounted on an equine or are in a vehicle (cart, wagon, buggy, etc.) being pulled by an equine. In Oregon and Washington, approved helmets are also required in Ground Training and In-hand Trail. An approved helmet meets the minimum performance standards imposed by the American Society for Testing Materials (ASTM) F1163 and includes certification and labeling required by the Safety Equipment Institute (SEI). The helmet must be properly fitted with the harness engaged and properly fastened according to manufacturer's recommendations. It is recommended that 4-Hers wear their ASTM/SEI helmets any time they are around their horse.

Western

Western clothing and equipment is appropriate in Western classes including, but not limited to, Trail, Western Equitation, Showmanship, Ground Training, Driving, Western Gaming, In-hand Trail, and Bareback.

Western attire

Required

- Long-sleeved Western shirt with any type of collar, tucked in, and sleeves rolled down
- Jeans, trousers, or Western pants
- Belt, unless loops are not present or are covered by another garment. (Belts are optional in Western Games.)
- Western boots
- ASTM/SEI-approved equestrian helmet

Optional

- Vest, jacket, coat, sweater, jacket with collar
- Gloves
- Ties, pins
- Chaps are allowed only in pleasure and trail in Oregon and Washington. In Idaho, chaps are optional in all classes except Showmanship.

Not allowed

- Chaps in Showmanship
- Whips or crops, except in Western Games
- Spurs in Showmanship, Driving, Ground Training, and In-hand Trail

Saddle and pad

Required

- Any standard Western saddle with a horn may be used, but it must fit the rider and the horse.
- Any clean saddle pad, blanket, or combination is allowed if it provides sufficient padding for horse and rider.
- If the cinch pin or tongue on the cinch is not being used, it must be removed.

Optional

- If a back cinch is used, it should be adjusted close to the horse and attached to the front cinch with a connecting strap.

Not allowed

- Australian saddles
- Tapaderos (stirrup covers)

Bridle and Bit

Horses 5 years old or younger may be ridden in a snaffle or bosal. For horses 6 years or older, a curb bit is highly preferred. Members showing horses 6 years or older in a snaffle or bosal must have a significantly better performance in order to be placed above a member showing a 6-year-old or older horse in a curb bit.

Horses 6 years and older shown in a snaffle or bosal may be ineligible for top county awards (at local discretion). In **Washington**, such horses shall be ineligible to advance to state 4-H

competitions. In **Idaho**, such horses shall be ineligible to advance to district 4-H competitions. In **Oregon**, these horses are eligible for the state fair.

Required

- Any Western bridle, including snaffles and bosals, is allowed.
- Most types of Western bits are acceptable.
- A snaffle must have a curb strap, curb chain, or bit guards.
- Overall bit length, as measured in the picture below, can be no longer than 8½ inches.



The correct measure of overall bit length is a vertical line from the uppermost part of the headstall slot to the center of the rein ring.

- Curb straps must be plain leather or chains at least ½ inch wide, and must lie flat against the jaw.

Optional

- Throatlatches on all bridles are strongly recommended for safety purposes.

Not allowed

- Sidepulls and other bitless bridles in performance classes
- Cavessons or nosebands in performance classes. Refer to the Western Games section for gaming bridle criteria.
- Mechanical hackamores, double wire snaffles, slip or gag bits, except in Western Games
- Rolled leather straps

Refer to the Western Games section for gaming bit criteria.

Reins

Only split or romal reins are allowed in Western Equitation, Trail, and Bareback. Single piece closed reins or “roping reins” are required in Western Gaming.

Only one hand may be used for reining when using a Western bit with shanks for Western Equitation, Trail, and Bareback. The rein hand cannot be changed.

When romal reins are used, no finger between the reins is allowed. In these cases, the romal goes on the opposite side from the rein hand. The rider’s hand shall be closed around the reins with the wrist kept straight and relaxed, the thumb on top.

There are two ways to hold split reins:

- The same as romal reins, with the free end of the rein (bight) in the opposite hand
- With the palm of the hand facing down and one finger between the reins. The free end of the rein (bight) falls on the same side as the “rein hand.”

When a bosal or snaffle bit is used, two hands must be used. Split reins should be held by crossing the reins between hands so that both hands are holding both reins. Closed reins are allowed with a bosal. Mecate reins can be half-hitched around the horn or properly tucked under (not tied to) the belt.

Other Western tack and equipment

Optional

- Spurs (if used) must be Western type and must be used properly.
- Hobbles
- Lariat or riata
- Breast collars
- Hoof boots may be used in place of shoes if they are fitted properly. They are not allowed in Western Gaming.

Not allowed

- Tie-downs, martingales, draw-reins
- Nosebands
- Tack collars

Splint boots, bell boots, bandages, and polo wraps are not allowed in Western Equitation, Trail, Showmanship, or medals classes. They are allowed in Western Gaming, Ground Training, and In-hand Trail.

Hunt Seat and Dressage

Hunt seat or dressage equipment and clothing may be used appropriately in Showmanship, Driving, Hunt Seat Equitation, Equitation over Fences, Trail, In-hand Trail, Ground Training, Dressage, and Bareback.

Attire

Required

- Ratcatcher, long-sleeved tailored shirt closed at the neck, or turtleneck shirt. Shirts are tucked in.
- Hunt coat if short-sleeved ratcatcher is worn
- Pants, breeches, or jodhpurs
- Tall hunt boots or jodhpur boots
- ASTM/SEI-approved equestrian helmet

Optional

- Hunt coat (conservative colors)
- Spurs must be English type and used appropriately. In Dressage, rowels must be blunt and smooth and free to rotate.
- Half-chaps
- Gloves (any traditional color allowed)
- Pins or ties

Not allowed

- Spurs in Showmanship, Driving, Ground Training, or In-hand Trail

Saddles and pads

Required

- Forward seat, close contact, jumping, or dressage seat saddle
- Stirrup safety bars must be in the open position in any Equitation over Fences class.

Optional

- Saddle pad

Not allowed

- Saddle seat-type English saddle or Western saddle

Bridle and bit

Required

- English bridle with cavesson
- Snaffle, pelham, kimberwick, full double bridle, or any other English-type bit appropriate for the seat

Optional

- Dropped, flash, and figure-8 nosebands are allowed in Dressage and Hunt Seat Equitation over Fences, but no other flat classes.

Not allowed

- Sidepulls and bit converters
- Double-twisted wire and gag bits

Other tack and equipment

Optional

- Breastplates or breast collars
- Martingales and any type of boots in Equitation over Fences only
- Running martingales may be used only with a snaffle bit.
- Whips or crops may be no longer than 36 inches for hunt seat.

Not allowed

- Martingales in flat classes
- Any type of boots in flat classes

Specific to Dressage

Required

- English bridle made entirely of leather or leather-like material (except for buckles)
- Plain, smooth snaffle bit in Introductory through 2nd levels. For appropriate bits for 3rd level and up, refer to USEF dressage rules. See the *4-H Dressage Manual* (PNW 608) for types of acceptable bits.
- The mouthpiece of any bit must be metal or rigid plastic and may be covered with rubber.
- Whips or crops may be no longer than 48 inches.

Not allowed

- Flexible rubber bits
- Strictly forbidden, under penalty of elimination: martingales, bit guards, accessories (bearing, side, running, balancing reins, etc.); any type of boots (including “easy boots”); bandages; any form of blinkers, ear muffs, or plugs; nose covers, seat covers, and hoods

Saddle Seat

Saddle seat equipment and clothing may be used appropriately in Showmanship, Saddle Seat Equitation, Trail, Ground Training, Bareback, and Driving.

Attire

Required

- Long-sleeved tailored shirt or short-sleeved shirt with a coat
- Tie

- Jodhpur boots (short)
- Pants or Kentucky jodhpurs
- ASTM/SEI-approved equestrian helmet

Optional

- A saddle-seat suit or day coat may be worn, but it must be a conservative color and will not be given preference by the judge.
- Spurs must be English type and in mounted classes only.
- Whip no longer than 48 inches, including lash
- Gloves, a four-in-hand or bow tie, and a pin or flower in the lapel are traditional, but not required.

Saddle

Required

- Saddle seat-type saddle

Optional

- Breast collars

Not allowed

- Dressage, hunt-type, all-purpose, or Western saddles

Bridle and bit(s)

Required

- Full double bridle (curb and bridoon), pelham, or breed-appropriate bit

Not allowed

- Martingales or tie-downs

CONTEST GUIDELINES

Show Classes

Any or all of the classes listed in this guide may be offered at a show or fair where 4-H classes are conducted. At pre-fairs, county fairs, or any state qualifying event, Showmanship is required.

Class Priorities

When management must choose between equitation and pleasure classes, equitation classes must take priority. For example, Western Equitation and Bareback Equitation must be offered before Western Pleasure. If entries warrant, Saddle Seat or Hunter Seat Equitation must be offered before English Pleasure classes. If entries warrant, it is recommended that all shows offer at least two equitation classes and a showmanship class; for example, Western Equitation, Bareback Equitation, and Showmanship.

Ribbons and Awards

4-H uses the Danish system of awards, in which every contestant receives an award: a flat blue, red, white, or participation ribbon. Trophies, rosettes, and other special recognition may be awarded in addition.

The standard breakdown for ribbons is:

- Blue award, 85–100 points
- Red award, 70–84 points
- White award, 69 points and below

Disqualified riders may receive a white or participation ribbon. The system may also be modified in classes that do not follow the same 100-point system or scoring criteria. These classes may include Dressage and Western Games.

Participation

Show management may invite participation from 4-H clubs outside the county or limit participation to 4-H members from its own county. This should be stated on the entry form.

PERFORMANCE GUIDELINES

Showmanship

Scoring

100 points total

Member

Neat and clean, properly dressed, prompt and alert, confident (poised),
courteous25%

Animal and equipment

Animal clean and brushed, in good condition, feet cared for. Halter and
lead fitted, equipment clean and safe25%

Showing the animal

Following directions, leading, turning, standing, backing, stopping,
showing to advantage, controlling on lead and in line, attention in line50%

The purpose of showmanship is to learn courtesy, good grooming, poise, confidence, and how to fit, train, and handle a horse. Showmanship is a demonstration of the member's ability to show the animal, in hand, to its best advantage. Conformation of the animal is not considered.

Attire may be Western or English. Driving attire is also allowed except for skirts or dresses.

The type of headgear for the exhibitor in Showmanship is optional. ASTM/SEI helmets, although not required for Showmanship, are encouraged. Either an appropriate hat or helmet must be worn.

Equipment

Halter or bridle

You may show your horse with a safe, properly fitted halter or show bridle, each complete with a throatlatch. You may use a bridle when it is appropriate to breed, attire, or both. If you show with a double bridle, you may use either the snaffle or curb reins for leading. The other set of reins is put over the neck near the withers. The halter and lead should be leather, rope, or webbing. The lead should be 6 to 10 feet (about 2 to 3 meters) long. Be sure the lead is long enough to allow picking up a hind foot.

Western tack. Horses must be shown in a halter.

Hunt Seat or Saddle Seat tack. Horses may be shown in a halter or show bridle when appropriate to breed, attire, or both.

Chain

For safety or control, using a chain under the chin or over the nose is permitted but not required. If used, the chain must be attached and used properly. A chain approximately 15 to 24 inches is long enough. You may run the chain through the ring on the side of the halter or through the ring on the bottom, then over the nose or under the chin to the other side. With a very long chain, you may run the excess up the off cheek. If your chain is too long, it may be doubled back through the bottom ring and snapped back to itself. In all cases, the snap should face out. When leading your horse, do not put your hand on the chain.

Whips and/or bats are not allowed.

Judging requirements

Horses should be well-groomed, clean, and clipped according to breed. The horse should also be well-trained to the required routine and well-mannered so that it stands quietly, but alertly, while in the class.

Exhibitors will be asked to demonstrate their ability to lead, turn, set up, and move their animals as the judge requests. Additional tests, as listed, may be asked.

The following principles always apply:

- Individual tests must be performed with the official(s) in the same relative position to each exhibitor.
- The exhibitor shall not stand directly in front of the horse.
- Use of the quartering system is required.
- Horses may be shown, trimmed, and groomed according to breed type.
- The exhibitor shall not touch his or her horse except when executing a requested test that allows touch (for example, sidepass and turn on the forehand) or to smooth the mane or forelock if the judge's inspection has disturbed the grooming. (Tails do not need to be smoothed.)

Tests

- Back horse
- Sidepass. The exhibitor may touch the horse.
- Turn on haunches (need forward motion)
- Turn on the forehand (need forward motion). The exhibitor may touch the horse.
- Lead at the walk or trot from either side
- Pick up the feet
- Stop and set up, square and balanced, or according to breed standard. Do not change hands to set up.
- Answer questions from project materials
- Perform a circle at a walk or trot

Equitation (Western, Hunt Seat, and Saddle Seat)

Scoring

100 points total

Member and appointments

Clothing, equipment, courtesy, poise15%

Seat and hands

Seat, posture, head, legs, hands, balance, distribution of weight, aids.....35%

Performance

Standing, starting, walking, jogging or posting trot, figure 8 or equivalent at lope or canter from walk, stopping, turning, backing, general control50%

The horse should do what the rider asks with the least possible effort on the part of the rider and least amount of resistance from the horse.

Gaited horses that pace, slow gait, fox trot, singlefoot, rack, or perform a running walk may be worked with the class, adjusting their speed to conform to the other horses. When riders are asked to post the trot on the rail or in a pattern, the intermediate gait is acceptable if that is the breed standard. However, if all other aspects of the performance are equal, a rider posting correctly will be given preference.

The member will be judged on correct posture, smooth gait transitions, and effective use of aids, with special emphasis on light hands. The performance of the horse is not to be considered more important than the methods used by the rider in obtaining the performance.

The member, horse, and equipment may be inspected at any time during the contest. Members using unsafe equipment may be asked to leave the ring.

Tests

- Regular or extended walk
- Regular or extended jog, trot, or intermediate gait. (In Western riding, the rider may sit the trot or lean slightly forward, keeping contact with the thighs, with more weight in the stirrups and the seat coming slightly out of the saddle. In either case, the rider must demonstrate an extended gait.)
- Lope or canter (on the correct lead or a counter canter)
- Hand gallop for Hunt Seat, extended canter for Saddle Seat, or extended lope for Western
- Perform figure 8s, serpentines, circles, straight lines, or other specific patterns at any of the above gaits
- Simple, interrupted, or flying lead changes
- Ride without irons or stirrups and drop and pick up irons or stirrups
- Haunch or forehand turn (need forward motion)
- Sidepass or two-track
- Transition from any gait to halt followed by “on the buckle” or loose rein
- Change of diagonals
- Pick up the reins (Saddle Seat only and only in line)
- Back up

- Stand for inspection
- Rollbacks (Western only)
- Mount and dismount. (Juniors may NOT be asked to mount.)
- Balanced stops
- Answer questions from project materials

Dressage Seat Equitation

Judging for Dressage Seat Equitation is based on overall correctness of position, relaxation and suppleness of the rider, lightness, and correct application of the aids. All movements should be obtained without apparent effort of the rider. The rider should be well balanced with loins and hips supple, and thighs and legs steady and well stretched downward. The upper part of the body should be easy, free, and erect with the hands low and close together without touching each other or the horse. The elbows and arms are close to the body, allowing the rider to follow the movements of the horse smoothly and freely and to apply the aids imperceptibly.

The rider's position, seat, and correct use and effect of the aids are to follow the judging requirements found in Training Level and First Level dressage tests.

In addition, the rider is judged on the ability to maintain tempo and rhythm with the horse, along with overall performance.

The movements or gaits that must be performed are medium walk, working trot (sitting and rising), and canter both ways of the ring. Transitions in gait are from medium walk to working trot to canter. The movements or gaits shall be performed by the exhibitors simultaneously, same as with other equitation classes. The judge may ask for additional tests, but only those allowed in the USEF dressage rules.

Tack requirements for Dressage Seat Equitation are the same as for the dressage tests. Refer to the *4-H Dressage Manual* (PNW 608) for types of acceptable bits.

Bareback Equitation

Exhibitors may be asked to perform any test listed under equitation. Western riders must sit the jog or intermediate gait. English riders must post the trot on the correct diagonal. No mount or dismount is allowed.

Hunt Seat Equitation over Fences

A horse should be at least 5 years old before going over jumps.

Safety is paramount. Counties are encouraged to hold introductory level classes such as trot-a-course, in which poles are on the ground; or beginning jumper classes, with jump heights of 18 to 24 inches maximum.

Performance

Exhibitors may be asked to perform any test listed under equitation. Performance will be judged on effective use of aids on the entire course. Emphasis will be on light hands, balance, correct posture, and seat on the flat and over fences. Excessive speed will be penalized.

Under direction of the judge, a safety inspection should be done before riders take any jumps. The inspection will include, but is not limited to, making sure the stirrup bars are open, the stitching on saddle stress points is in good repair, the girth is snug, and the bridle is properly fitted and in good repair.

Maximum recommended jump heights:

- 2 feet 3 inches for juniors
- 2 feet 6 inches for intermediates
- 2 feet 9 inches for seniors

Jump height is not to exceed 3 feet, and the spread is not to exceed the height.

At least one **supervised** warm-up jump must be available prior to the class. It is preferable that the warm-up jump not be on the course or inside the arena or pattern area. The number of times a competitor can practice a supervised warm-up jump is specified by the show committee.

The course will consist of 6 to 12 jumps, performed at a canter, with at least one change of direction. The judge may ask the class to do rail work at a walk, trot, and canter both ways of the ring.

The rider will be allowed to circle **one time** before starting the course. A refusal will be called when a horse avoids a jump or stops forward motion. If the refusal is at a combination jump, the rider must retake all elements of the combination. Faults such as knock-downs and touches will not be considered unless they are the fault of the rider.

Types of fences

Required

- Spreads should not exceed the height of the fence.
- Wings at least 12 inches higher than the jumps and 30 inches wide are compulsory when jumps are less than 12 feet wide.
- The distance between standards should be a minimum of 9 feet.
- Ground poles or lines are required.
- Courses should have at least four different types of jumps and one combination jump (24 or 36 feet apart).

Optional

- Basic types of fences are allowed; for example, post and rail, wall, gate, brush, coop, planks, and picket fences.

Not allowed

- In-and-outs are not to be used at the start of the course.
- Use of striped rails is discouraged.
- Triple bars, hogsbacks, targets, square oxers, hinged chicken coops, or any bizarre or dangerous jumps

Major faults

- Refusal(s)
- Loss of stirrup
- Trotting while on course
- Loss of reins
- Excessive speed
- Lack of control

Disqualifications

- Fall of horse or rider
- Three cumulative refusals
- Off course

Dressage

Performance

Test requirements are the same for juniors, intermediates, and seniors. Tests are to be ridden and judged according to USEF dressage rules except where noted in this contest guide. Tests to be used are the current approved USEF tests, which are usually updated by USEF every 4 to 5 years. Exhibitors should make sure they are using the most current test each year. Tests may be read, but must be limited to reading each movement one time only, as it is written.

At any show that qualifies the member for state/district, only the first dressage test ridden is officially scored. For learning purposes, a second test can be ridden if it is different from the first, but it will not be scored. In **Washington**, the number of tests ridden and scored is at show management discretion, as counties determine specific qualifying criteria for State 4-H Fair.

A ride is to be judged on the horse's gait, impulsion, and submission; the rider's position and seat; and the correctness and effectiveness of the aids. Each movement is scored (0 to 10 points) to establish whether it was insufficient (4 or below) or sufficient (5 or above). Additional information on how to ride the test and how the test is to be judged can be found in the *4-H Dressage Manual* (PNW 608).

Western Dressage

Counties that offer Western Dressage should use the North American Western (NAW) Dressage tests. The walk/trot test and Intro C are suggested.

Trail

The trail class is an under-saddle mounted test of horse control and the rider's ability to guide the horse through a series of obstacles. The course must be safe for horse and rider. The obstacles may be progressively harder for each age group.

The course should not be spread out over a very large area; obstacle spacing must allow the horse to move easily between obstacles with no wasted time. The course should be designed to be completed in less than 5 minutes.

The rider may show English or Western. See clothing and equipment specifications for proper tack and attire. Riders moving on to championship classes must ride the same seat as in the first class.

Courses must be posted showing the order and direction of the obstacles. Each disturbed obstacle must be measured and reset for the next rider. Courses will contain 6 to 10 obstacles which may be used individually or in combination. See Table 1 (page 22) for obstacles and suggested spacing.

Unsafe or unnatural obstacles are not permitted, such as stepping into tires, a water box with floating or moving objects, fire extinguishers, or cinder blocks.

Judging is based on safety, performance, way of going, responsiveness, willingness, and general attitude with emphasis on manners. Riders may be asked to move on at the judge's discretion or after three refusals or attempts.

In-hand Trail

This class is an in-hand test of horse control and of the handler's ability to guide the horse safely through a series of obstacles. Handlers may wear Western or English attire. In Oregon and Washington, ASTM/SEI helmets are required.

The horse must be unsaddled and shown in a safe, properly fitted halter. A chain may be used. Guidelines for the use of a chain and for the halter and lead may be found in the Showmanship section (pages 15–16).

Attire

Required

- ASTM/SEI helmet

Optional

- Either Western or English

Not allowed

- Spurs
- Chaps

Tack and equipment

Required

- Halter with throatlatch and a lead line, suitable for the horse

Optional

- Correctly attached chain, only if used properly (see Showmanship equipment)
- Boots, bandages, or both on the horse

Not allowed

- Bridles
- Whips or crops

Course

The course will be designed so that exhibitors can move quickly and smoothly between obstacles. The course should contain 6 to 10 obstacles and should be designed to be completed in less than 5 minutes. Care should be taken so that there is no advantage to either a large or a small horse. The course should be designed to be suitable for all breeds and sizes.

Obstacles

Obstacles can be generally the same as for a standard trail class, except lope/canter obstacles are not allowed.

When deciding whether the handler should go over obstacles with the horse or work inside poles, boxes, etc., safety should be the primary consideration. This could depend on the size of the horse and the size of the obstacle. The handler must stay out of the danger zone.

If there is a definite preference for how an obstacle should be completed, this should be clearly stated in the pattern.

Basis for judging

Emphasis is placed on safety, the horse's manners and response to the handler, and the quality of the movement. The exhibitor should be poised, confident, and courteous and should display safe and quiet techniques in handling the horse. Handlers may be asked to move on after three refusals or at the judge's discretion.

Disqualifications

- Horse gets loose
- Extreme disobedience

Table 1. Mandatory dimensions of trail obstacles

Measurements are made from center of pole to center of pole.		
	Mounted	In-Hand
Walk Trot Lope-Overs	Maximum height 10 in. 20–24 in. apart for walkover 3–3½ ft. apart for the jog 6–7 ft. apart for the lope/canter Spoke style should be set 24 in. apart halfway. No freely rolling poles allowed	20–24 in. apart for walkover 3 ft. apart for trot overs 10 in. maximum height
Back-throughs	Minimum of 28 in. wide on ground Minimum of 30 in. wide elevated Minimum of 32 in. wide for barrels or cones	On ground only 36-in. minimum width if handler is inside poles
Sidepass	Minimum of 24 in. between poles Maximum height of 24 in.	Minimum of 30 in. between poles On ground only
Serpentines	Cones minimum 6 ft. apart Guardrails (if used) 3 ft. to either side Cones minimum 3 ft. apart Guardrails (if used) 6–8 ft. to either side If tall standards are used, dimensions can be looser.	Cones minimum 4 ft. apart for walk Guardrails (if used) minimum of 4 ft. from cones Cones minimum 7 ft. apart for trot Guardrails (if used) minimum of 4 ft. from cones
Gate	Latch 54–60 in. high Minimum of 4 ft. wide Rope gate optional	Minimum 4 ft. wide Rope gate optional
Jump	Maximum height 16 in.	Maximum height 16 in. Minimum width between standards 12 ft.
Bridge or Plank	Must lie flat on ground Minimum of 12 in. wide for a plank Minimum of 36 in. wide for a bridge	Must lie flat on ground Not to exceed 12 in. high Minimum 48 in. wide if handler to be on the bridge
Ground Tie or Hobble	Inside a minimum 6-ft.-diameter circle	Inside a minimum 6-ft.-diameter circle
Mailbox	Must be a minimum of 48 in. from the ground to the bottom of the mailbox	Must be a minimum of 48 in. from the ground to the bottom of the mailbox
Turn in Box	Minimum 6-ft. sides	Minimum 8-ft. sides
Other obstacles you may want to consider	Tie horse properly, pick up horse's feet, carry item, dismount and mount (juniors will not be asked to mount), walk through brush, walk by a hide or noisy object	Tie horse properly, pick up feet, walk by a hide or noisy object
Obstacles not allowed	Tires, walking on plastic, cinder blocks, fire extinguishers, water boxes with floating or moving objects, PVC pipe, live animals, wire gates, unsafe or unnatural obstacles	Tires, walking on plastic, cinder blocks, fire extinguishers, water boxes with floating or moving objects, PVC pipe, live animals, wire gates, unsafe or unnatural obstacles

DRIVING

Appointments

Animal

Exhibitors may drive a single horse, pony, miniature, mule, or donkey. Classes may be divided into 4-H member age groups, by the size of the animal, or both. The animal must not be asked to pull too much weight (see *4-H Driving Manual* [PNW 229] for specifics). When determining animal height, allow an additional ½ inch if shod.

Natural gaits are desirable. Chains are prohibited. It is permissible to stretch or park your horse if breed and turnout are appropriate.

Attire

Required

- Neat, clean, and well fitted
- Riding boots or sturdy leather shoes
- Gloves (may be black or brown, but brown is traditional)
- Driving whip
- ASTM/SEI helmet

Optional

- English or Western riding attire

Additional options and restrictions for attire:

Gentleman—Sport coat and slacks or suit (Western cut acceptable). A driving apron is optional.

Lady—A long-sleeved shirt or blouse with jeans, slacks, or an ankle-length skirt; or a conservative dress with long sleeves. A vest or jacket may also be worn. A driving apron is optional. Evening wear is not acceptable.

Header—Hard-soled shoes or boots, a long-sleeved shirt, and jeans or slacks. If the header is a 4-H member, an ASTM/SEI helmet is required.

Vehicle

Required

- An appropriate two- or four-wheeled vehicle
- A footrest or basket (a minimum of 10 inches front to back) securely fastened to the vehicle. The basket must be constructed so the driver's feet cannot get stuck.
- Shafts should be equipped with a single tree or trace hooks.
- The vehicle should be in safe, usable condition and should fit the animal to which it is attached.

Not allowed

- Racing sulkies or roadster bikes

Harness

A leather or synthetic, pleasure-type harness is acceptable. For safety reasons, a nylon harness is not recommended. The harness must be in safe, useable condition and must fit the animal wearing it. The reins must be either buckled or stitched together.

Required

- Crupper
- Thimbles or breeching (unless the vehicle is equipped with a braking system)

- Wrap straps or overgirth
- Blinkers (or blinders)
- Cavesson noseband
- Snaffle or driving curb bit

Not allowed

- Twisted wire or gag bits

Optional equipment

- Overcheck or sidecheck
- Running martingale
- Kicking strap (recommended)
- Support boots, quarter boots, splint/brushing boots

Whip

Required

- Driving or buggy whip. It should be carried in the right hand.

Not allowed

- Longeing-type whip

Safety

Management

Any entry the judge feels is unsafe may be dismissed whether due to turnout or behavior of the animal. Management should permit only the number of entries that can be shown safely at one time for the size of the ring. Age divisions may be combined if classes are small.

One properly dressed intermediate, senior, or adult header is required for each driver in the lineup. The header should enter the arena once all the entries have lined up and permission to enter has been granted. The header should not touch the animal except in case of a potential emergency.

Exhibitors

Do not lead your horse by the harness with no one in the cart.

Extreme speed will be penalized. Pass other vehicles on the inside, watching the traffic. Avoid cutting back to the rail immediately in front of another driver.

In case of a runaway, all other drivers are to move off the rail to the center of the arena and stay in their vehicles. Most frightened horses will run the rail looking for a way out.

Driving Classes

Reinsmanship

Scoring

100 points total

Appointments

Proper harnessing and hitching; condition of equine, harness, and vehicle ...25%

Driver

Handling of reins and whip, control, posture, and overall appearance35%

Performance

On rail and in pattern40%

Basis for judging

Reinsmanship is judged as an equitation class on hands, proper harnessing and hitching, and correct driving techniques. The driver should be able to change gaits quickly, smoothly, and unobtrusively while always maintaining contact and using correct driving techniques. This class is designed to test the driver's knowledge and ability. A pattern is required. Extreme speed or extreme high action due to a horse's length of foot, pads, or weighted shoes will be penalized.

Class procedure

Drivers enter and line up a safe distance apart, with headers, for inspection by the judge. Drivers proceed at the direction of the judge on the rail and work both directions of the ring at a flat-footed walk, slow trot/jog, working trot, and strong trot/extended trot. The reverse will be executed on a diagonal at a walk or working trot from a designated corner at the direction of the judge or ring steward. Drivers line up according to instructions by the judge or ring steward. Horses must stand quietly in line.

Suggested pattern elements

- Back four steps and close the back.
- Drive a circle of specified size.
- Drive a figure 8.
- Drive at a strong trot.
- Negotiate a simple obstacle (i.e., drive between two obstacles at a working trot or halt between two given markers).
- Pivot (turn) with one wheel in place, left or right, 90, 180, or 360 degrees, at the judge's direction.
- Back between two markers.
- Drive at a lengthened flat-footed walk.
- Answer a 4-H driving question posed by the judge.

Patterns may include other elements.

Precision Driving

Scoring

100 points total

A perfect score of 100 points is based on a maximum of 80 points for a fault-free* performance and 20 points for reinsmanship and overall smoothness of the performance. Faults are deducted in 5-point increments from the possible 80, while single-point deductions are made from the 20 points.

Example: A driver incurs three faults and receives a score of 13 for reinsmanship/performance. The three faults (at 5 points each) total 15 points; these are deducted from 80, resulting in 65 points. Those 65 points along with the 13 reinsmanship/performance points yield a final score of 78.

Basis for judging

The Precision Driving competition tests the skill of the driver, the obedience and handiness of the animal, and the accuracy with which the course is driven.

Class procedure

All drivers must submit to an inspection by the judge before starting the course. Competitors will be required to drive over a course consisting of 6 to 8 obstacles. Markers may be used to indicate obstacles (traffic cones with tennis balls on top work well). A course may be set up using only cones with tennis balls if other obstacles are not available. The course will be irregular, necessitating changes of direction.

Measurements

- Markers indicating obstacles will be at least 12 inches wider than the track width of each vehicle (measured from the outside edge of one wheel to the outside edge of the other wheel).
- Markers must be at least 12 inches high.
- Lanes may be defined by rails at least 3 inches in diameter.
- If the course calls for a walk between poles (the vehicle's wheel goes between the poles), the poles must be 6 to 8 inches apart.
- If the course calls for a trot between poles (the vehicle's wheel goes between the poles), the poles must be 10 to 12 inches apart.
- Serpentine cones should be at least 27 feet apart with cones set on a straight line.
- Figure 8s should have a minimum of 30 feet between two marker cones.
- Squares should have at least 10-foot sides.
- L-shaped obstacles should be at least 10 feet wide.
- U-shaped obstacles should be at least 10 feet wide.
- Bridges should be a minimum of 8 feet wide and 12 feet long with cones at all four corners (minimum 4-foot ramp up, 4-foot flat surface, and 4-foot ramp down).

* *Faults:* First and second refusal, displacing any marker, hoof or wheel outside marker, and breaking gait will each incur a 5-point deduction.

Elimination: Three cumulative refusals, receiving outside assistance of any sort, showing an obstacle to the horse, or taking an obstacle out of order (off course)

PRECISION DRIVING COURSES (SUGGESTIONS ONLY)

Sample course #1:

1. Enter at a trot.
2. Trot through a 10-foot square (4 cones).
3. Trot a serpentine of 5 cones (25 feet apart).
4. Walk with right wheel(s) between poles (6 to 8 inches apart).
5. Trot a figure 8 (at least 30 feet around A then B).
6. Walk with left wheel(s) between poles.
7. Walk a serpentine.
8. Walk into square, stop with front wheels between front cones, back up 4 steps, and return to forward position.
9. Stand quietly until dismissed by the judge or ringmaster.

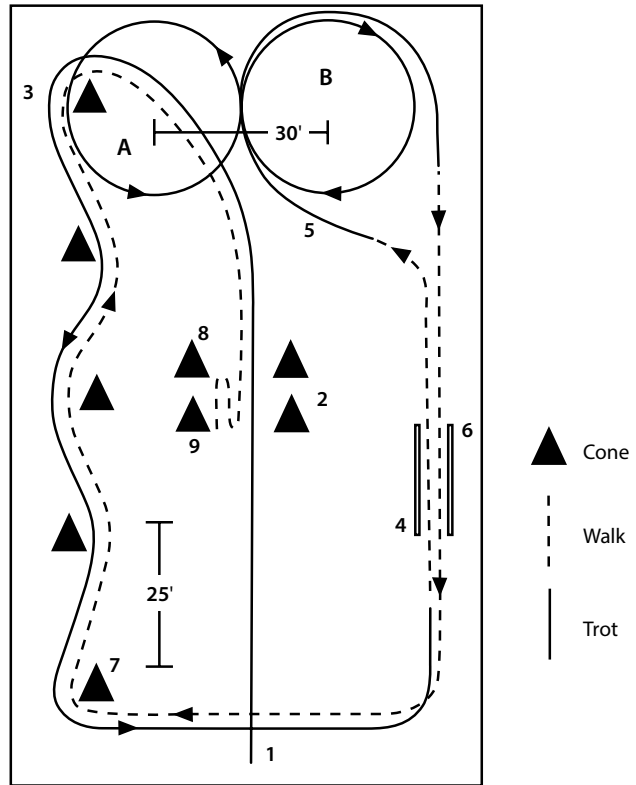

Sample course #2:

1. Enter at a trot.
2. Trot through two pairs of cones (CDEF, 10-foot square).
3. Trot a figure 8 (B, then A).
4. Trot a serpentine of 5 cones (25 feet apart).
5. Walk with right wheel(s) between poles (6 to 8 inches apart).
6. Walk to the top of the cone square. Halt with cone C on your left, facing the serpentine. Pivot 90 degrees to the right. Back into the square, between cones C and D, until the cart is between E and F. Halt and stand 10 seconds. Trot back forward through the box.
7. Trot with left wheel(s) between poles and exit.

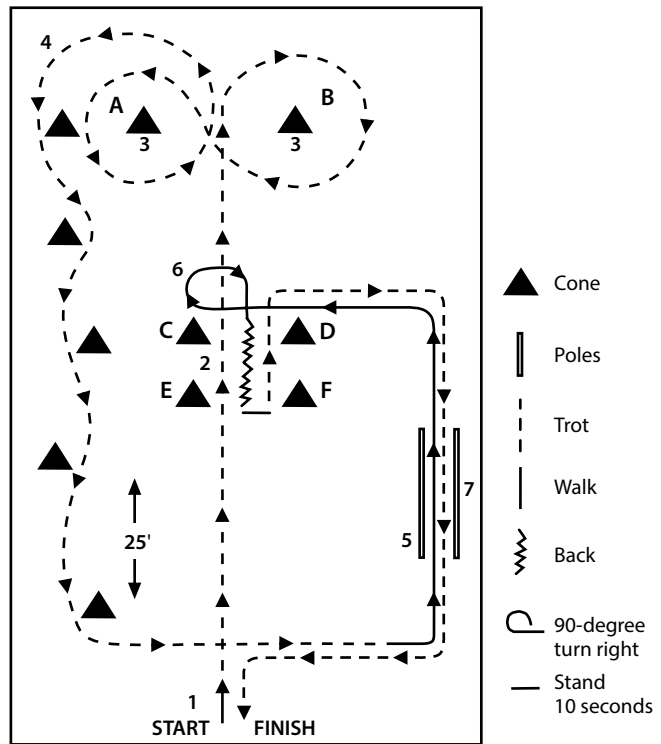

Pleasure Driving

Scoring

100 points total

Appointments

Fit, condition, and appropriateness of harness and vehicle.....10%

Driver

Handling of reins and whip, control, posture, and neatness of attire30%

Performance

Manners, performance, condition, style, and way of going.....60%

Basis for judging

The Pleasure Driving horse should have the same general qualities as the Pleasure Saddle horse. Special emphasis is placed on the flat-footed walk and the pleasurableness of the ride for the driver. The horse should be in balance with a head and carriage typical of its breed or type, be light-mouthed, and have a free way of moving. At all gaits, it must work in form (i.e., head held quietly, mouth closed, and legs working beneath itself). The traces should be steady at all times, demonstrating consistency of forward motion and that the horse is pulling from the traces, not from the mouth or saddle. Erratic movements are highly undesirable. Hesitation or breaking stride will be penalized. Extreme speed or extreme high action due to the horse's length of foot, pads, or weighted shoes will be penalized.

Class procedure

Drivers enter and line up a safe distance apart, with headers, for inspection by the judge. Drivers proceed at the direction of the judge on the rail and work both directions of the ring at a flat-footed walk, slow trot/jog, working trot/jog, and strong trot. The reverse will be executed on the diagonal at a walk or working trot from a designated corner at the direction of the judge or ring steward. Drivers line up according to instructions by the judge or ring steward. Horses must stand quietly in line.

THE E.L. “DAD” POTTER AWARD

The E.L. “Dad” Potter 4-H Horsemanship Award is sponsored in memory of E.L. Potter, Oregon State University (OSU) professor, expert horseman, teacher, and developer of 4-H horse projects.

The trial is a test of finished horsemanship for horse and rider. It is the highest horsemanship honor an Oregon 4-H member may attain.

To be eligible to try out for the “Dad” Potter Horsemanship Award, riders must:

- be enrolled in the Oregon 4-H Horse program;
- have owned, leased, or cared for the horse they will ride for at least 6 months;
- have personally trained the horse they will ride for at least 6 months; and
- have completed all three levels of the knowledge, groundwork, and riding advancements of the Oregon 4-H Horse Advancement Program.

To achieve a “Dad” Potter Award, all 10 steps must be completed accurately at the same trial. One corrected mistake is allowed.

During the trial, the rider must use seat, hands, and leg aids properly. The horse must be quiet, well-mannered, and under full control. It must also be in good condition and well-groomed. Tack and attire may be either English or Western, but all must be suitable, neat, clean, safe, and in good condition. Spurs, if worn, may be removed between movements.

Arrangements

Arrangements for scheduled trials must be made with the approval of a county agent of the OSU Extension Service and a 4-H leader. This will include the time, place, and acquisition of an approved “Dad” Potter judge as noted on the most recent version of the PNW 4-H Judges List. Trials approved by non-certified judges who misrepresent their status on the list will be rejected when the application is sent to OSU for approval.

Trials are often held in conjunction with fairs, but this is not necessary. They must be announced early enough so that all interested members have an opportunity to participate. Members may participate in multi-county tryouts. Spectators are encouraged to attend.

The trial area should be a minimum of 50 x 100 feet of smooth, level ground with good footing. The judge should inspect this area personally, and the rider and horse should have time to become acquainted with it. There should be no distractions. If the judge decides that an error is due to an outside distraction, the member should be allowed a brief time to calm the horse and to repeat the movement without penalty.

The rider may select the sequence in which to perform the movements and should indicate when he or she is starting a movement. The order of movements must be listed in the column on the left side of the score sheet, as the rider wishes, except that Number 10 cannot be done first.

The signed “Dad” Potter form must be presented to the judge before the test begins.



General instructions to the judge

A measuring tape and a watch with a second hand are required. Judges should keep in mind that this is not a dressage test of unified movements; it is a series of individual tests. Riders should be permitted to relax their mounts briefly between tests by making a circle or two, or taking a few steps for better footing or location.

General instructions to the rider

Only one error is allowed and it must be corrected, either at once or later during the trial, as decided by the rider. Any additional error will disqualify the contestant. If all movements are completed with only one error that was corrected, the rider qualifies for the award.

Contestants who fail are eligible for future trials, but not on the same day. In case the above requirements are not met to the full satisfaction of the judge, the judge is authorized and instructed to refuse the award.

Second award

If the rider is competing for a second “Dad” Potter award, it must be done with a second horse the rider has raised and trained from a foal. The rider must have done all the training. A statement confirming this must accompany the application.

Movements required

1. Walk forward and backward the exact number of steps indicated by the judge; repeat two more times. The rider must specify the exact way the steps will be counted (all four feet or a specific foot). The number of steps requested may vary for each repeat. Do not count the last half step to bring the feet even. The front feet should be approximately within half the hoof's length of being even at the end of each move. An inadvertent half step in the opposite direction is a fault (i.e., a half step forward when collecting the horse to back).
2. Side step right and left (the number of steps specified by the judge) with at least 12 steps, or six crossovers, in each direction (one crossover is two steps); repeat. The forefoot must cross in front of the stationary foot. The hind feet must cross in front or be placed side by side. Balance the horse before changing directions.
3. About on the forehand, a full 360 degrees one way and then the other; repeat. The horse may be repositioned before repeating. The movement must be done with forward motion, with no backing around the pivot foot. The pivot foot must be the inside forefoot. It may move within a 24-inch diameter circle (12-inch radius from starting point). The rider must not be asked to place the horse inside a circle drawn on the ground. The judge will be prepared to measure a questionable distance. Keep forward motion.
4. About on the haunches, a full 360 degrees one way and then the other; repeat. The pivot foot must be the inside hind foot and may move only within a 36-inch-diameter circle (18-inch radius from its starting point). Keep forward motion.
5. Two track at least three times in each direction as requested at a walk or trot. The horse's body must be kept straight ahead while tracking at a 45-degree angle. Forward motion must be combined with side motion in a consistent 45-degree line of travel. Allowing the horse to lead with its shoulders, then quarters, is not acceptable. The distance each way must be reasonable and not tire the horse. Two steps of forward motion are allowed before the horse changes direction. The rider should not be asked for an exact number of steps.

6. Start a jog trot from a standing position; repeat two or more times. No walking steps are allowed. The diagonal feet should come up at the same time to start the two-beat trot. Proper collection and impulsion are required for a smooth start. Do not post.
7. Post the trot on a straightaway, starting on either diagonal, changing diagonals at least three times as requested by the judge; repeat two more times. Demonstrate good equitation and smooth changes with no extra bumps.
8. Perform one figure 8 at a posting trot (change to the correct diagonal at the trot), then, without halting, execute a second figure 8 at a canter using a simple change of lead. Halt. Execute a third figure 8 at a canter using an interrupted change of lead. Start the canter from the halt, with no walking or trotting steps.
9. Execute one figure 8 demonstrating two complete flying changes of lead, continuing on to two circles to the right (or left). Make a third complete flying change of lead and two circles to the left (or right). Halt at starting point. Changes of lead may be executed with either the front or rear legs changing first. A delayed half stride in the rear, or disunited change, is not allowed.
10. Starting from a walk and at least 20 feet from a wall or fence, pick up a canter immediately. Execute two complete flying changes of lead on the straightaway. Maintaining the canter, return to the center of the arena and halt. Allow the horse to settle and stand for 30 seconds without moving any foot. (Thirty seconds are allowed to settle the horse.) The rider will indicate to the judge when the 30-second count should start, and this will be timed with a watch. The horse must not be canted, or angled, for the lead changes; only a slight leading of the correct shoulder and haunch is acceptable. Trotting steps, a disunited change, resistance by the horse, charging, or unplanned changes are not acceptable.

Three-step Certificate of Merit

The purpose of the three-step E.L. “Dad” Potter 4-H Certificate of Merit is to provide incentive to Oregon 4-H members to attempt and perfect movements one through ten of the “Dad” Potter program, eventually leading members to attempt the full ten-step trial.

Members must have completed the knowledge and groundwork advancements for their age level and must have passed the riding advancements for the steps they are attempting. Arrangements are the same as for the “Dad” Potter trials.

A Certificate of Merit is awarded to 4-H members who pass any three movements at one trial. Members must decide the three specific movements they will attempt prior to the test, and only three steps may be attempted on a given day. No errors are allowed during the trial.

Certificates of Merit are awarded to horse-and-rider combinations. Once a certificate has been awarded, those three steps cannot be repeated in future three-step trials with the same horse. A member may, however, repeat steps with a different horse.

The three-step program is NOT a consolation award for members who attempt the ten-step “Dad” Potter Horsemanship Award and only pass some of the steps. Nor do completed three-steps accumulate into a “Dad” Potter Award. Members must state in advance if they are trying for the three-step certificate or ten-step award.

WASHINGTON STATE MEDALS PROGRAM

The medals program in Washington counties is optional. The value of a medals program is to establish an educational challenge for advanced riders. Gold, silver, and bronze medals may be awarded to intermediate and senior 4-H youth in a variety of classes, including Western Equitation, English Equitation, Showmanship, Hunt Seat Equitation over Fences, Driving, Trail, and Dressage.

Medals are awarded on a pass/fail basis. Riders can do a pattern correctly but still not receive a medal if they have done a sloppy pattern or shown poor equitation. Awarding a medal is completely at the judge's discretion. When competing for medals, the exhibitor is riding against a standard of excellence.

Standard patterns are available on the WSU 4-H website for counties to use. These patterns are recommended for consistency by the PNW horse judges and Washington Equine Committee.



IDAHO HORSEMANSHIP AWARD

Competition for the Idaho Horsemanship Award is a test of knowledge and skill in horsemanship. The purpose of the award is to honor the most talented youth riders in Idaho. The competition tests the youth's riding ability and knowledge of equine subjects that are important for a well-informed and proficient horseperson to know. The Idaho Horsemanship Award not only sets a high level of horsemanship goals for the young horseperson, but also recognizes evidence of their citizenship and leadership abilities.

Any youth 14 years of age by January 1 and not more than 19 years of age during the calendar year, and enrolled in an organized horse program, may apply for this award. It is recommended that the applicant have participated in the 4-H Horsemanship program or other organized groups, such as Scouts, breed associations, or pony clubs.

The applicant must own or manage the horse used to compete for this award for a minimum of 120 days before the performance test. The test can be ridden in Western tack and attire or English tack and attire.

The Idaho Horsemanship Award program is administered through the University of Idaho (UI) 4-H Youth Development office. The program is conducted in each of the four Extension Districts by the District Horse Award chairperson and/or district representatives.

Application forms are available at each county Extension office in the state or on the UI 4-H Youth Development website. The contestant's application form must be approved by his or her leader or instructor and returned to their county Extension office.

Each Extension district representative has predetermined deadlines for the written and performance phases of the evaluation. Please contact your county Extension office to get those dates.



GROUND TRAINING

Currently, Ground Training is an Oregon-only class. If counties in other states want to offer this class, refer to the “Basic Colt Training” section in *The 4-H Horse Project* (PNW 587).

The intent of Ground Training is for 4-H’ers to demonstrate training techniques and accomplishments with their young horse. It is important that the exhibitors have personally done the training for the techniques they demonstrate. The horse may have some training by others, but only what is necessary for basic care and handling. Members should show steps that they personally trained the horse to do.

Ground Training is open to weanlings, yearlings, and 2-year-olds. Only yearlings and 2-year-olds are allowed at the Oregon State 4-H Fair. **Animals entered in Ground Training classes cannot have been mounted at any time.** A Ground Training animal may also be entered in Showmanship but not in Equitation or Driving.

An enclosed, reasonably quiet area should be provided for this class. A time limit of 15 minutes maximum will be placed on each contestant. No more than 5 minutes will be allowed to bring in and set up equipment.

Each contestant must give the judge, in advance, a ground training score sheet that lists the items to be attempted. The score sheet is available at Oregon county Extension offices and on the Oregon State University 4-H website.

Only age-appropriate items from the back of the score sheet may be attempted. Contestants must attempt a minimum of three items and a maximum of ten items.

Ground Training is NOT an In-hand Trail course. Minimal equipment (poles, barrels, etc.) should be used. Any obstacles not allowed in trail (walking on plastic, cinder blocks, etc.) are not allowed in Ground Training. In addition, the judges may eliminate any items they feel are unsafe.

The handler may wear Western or English attire. In Oregon and Washington, an ASTM/SEI helmet is required. One properly dressed attendant is allowed in the ring with the exhibitor. The attendant must also wear an approved helmet. The role of the attendant is to hold the horse, equipment, or both. It is preferred that a knowledgeable intermediate or senior 4-H member perform attendant duties, but an adult may do so if a qualified 4-H’er is not available.

Scoring is based on how well the items attempted are accomplished and whether adequate progress has been made during the time in training.



WESTERN GAMES

General Information

The primary purpose of Western Games is to provide an educational forum in which youth enrolled in the 4-H Horse program demonstrate their ability to safely navigate a prescribed course in the fastest time possible. Events are timed games on horseback and are individual in nature.

Approved events include:

- Figure 8 Stake Race
- Idaho Figure 8
- Pole Bending
- Key Race
- Barrels
- Keyhole Race
- Two-Barrel Flag Race
- NSCA (International) Flag Race

Counties may run other individual events as long as they are as safe or safer, they have rules from a recognized gaming organization, and the county agent and state staff person agree in advance. Usually, team events are not appropriate. Rodeo, racing, and bareback gaming events are prohibited.

4-H Western Games require the humane treatment of all animals entered in state and county competitions. Exhibitors are expected to treat their animals with respect and provide for the animal's continuous well-being through proper feeding, handling, disease prevention, sanitation, and attention to the animal's safety. Officials should be prepared to dismiss any exhibitor who abuses or mistreats their animal.

Horsemanship, sportsmanship, and safety will be stressed in all Western gaming classes. The safety of the exhibitors, horses, and volunteers is the most important aspect of the program.

Exhibitors may be asked to submit to a close inspection before any event. The purpose of the close inspection is to demonstrate an exhibitor's ability to handle and control his or her horse in a safe manner. The close inspection also provides the show management an opportunity to examine the exhibitor's tack and equipment. Exhibitors failing the close inspection will not be allowed to make their scheduled run in that event.

Scoring

Exhibitors must compete within their appropriate junior, intermediate, or senior age group. The state competition allows only intermediate- and senior-age youth to enter.

Participants are timed, then arranged in numerical rank order, and then divided into predetermined blue, red, and white ribbon groups. This system is referred to as the modified merit system of judging. Individuals receive a basic score equivalent to the number of seconds (to the nearest hundredth) that it takes to complete the event. Penalty points are added to this score.

Recommended Awards

The Danish system of awarding ribbons is recommended for Western Games. Counties may also use the American placing of ribbons (1st, 2nd, 3rd, etc.) in addition to the Danish awards. The awarding of ribbons is based on the rider's time in each event.

Each state has its own method for establishing ribbon divisions. Disqualified riders receive white ribbons, participation ribbons, or no award.

General Rules

In **Oregon** and **Idaho**, contestants may not enter the same gaming event more than once at one show, whether on the same horse or another horse. In **Washington**, entries are at county discretion.

Riders may hold onto the saddle horn. Two hands may be used on the reins, and hands may be changed. Riders must wear their exhibitor number on their back or both sides of their horse at all times while mounted.

Clothing and tack

Required clothing

- Standard 4-H Western (See “Western attire,” page 10)

Optional clothing

- Belts

Required tack

- Western saddle with a saddle horn
- Throatlatch on the bridle
- Curb strap on all bits
- Roping or single piece reins

Optional tack

- Running martingales with rein stops
- Breast collar
- Tie-downs attached to a breast collar
- Nosebands
- Draw reins
- Splint boots, bell boots, or bandages
- Mechanical hackamores
- Gag bits
- Whips under 36 inches, bats, or quirts

Not allowed

- Mecate reins
- Tied split reins
- Buckled reins

Riders will be disqualified if the judge considers equipment inhumane or dangerous, or if equipment breaks and the rider is unable to safely continue without repairs.

Bats, spurs, and over-and-unders will be open to inspection by the judges. Spurs, if worn, must be Western type and used properly. Should these properties be found to be abusive by nature (such as pronged, weighted, or cutting), they shall be banned from use. No warning will be required.

Gaming equipment

Plastic 55-gallon barrels are recommended. Eight to 12 pounds of water or clean, dry sand is recommended as an appropriate filler material. Metal barrels are strongly discouraged. If no other alternative exists, metal barrels must have a protective material (such as a rubber bicycle tire) placed around the upper, outermost portion of the rim where the barrel could come into contact with the rider's lower leg.

Poles must be 1 to 1½ inches in diameter and 75 to 85 inches tall. Poles may be white or striped, depending on the event and situation. If striped poles are used, they must have two stripes, each

3 inches wide. The first stripe is 1 foot from the top, and the second stripe is 1 foot from the bottom of the first stripe. All poles must be made of material that will not splinter, such as schedule 40 to 80 plastic pipe (schedule 80 pipe is the most durable). Pole bases, weighing approximately 14 pounds, should be 6 inches tall, 14 inches across, and made of black rubber. The total weight of the pole and base should be approximately 16 pounds.

An electronic timer and reader board are recommended. At county qualifying gaming competitions, if an electronic timer is not available, a hand-held stopwatch that measures times to the nearest hundredth of a second should be stationed at the start and finish lines of each game.

Ties

The recommended procedure for breaking ties is a runoff or toss of a coin. When breaking a tie with a runoff, the rider with the slower time takes the next lower position. If there is still a disagreement, the judge's decision is final.

Mounted riders

Riders are considered mounted when their knee is over the center line of the horse's back. Riders must remain mounted until the judge's final acknowledgment.

Re-rides

Re-rides are run after the last rider in that event. Penalties do not carry over from the original ride.

Acceptable reasons for re-rides:

- Timing device failure
- Course obstruction as determined by the judge
- Course measured incorrectly

Unacceptable reasons for re-rides:

- Horse or rider damage to arena equipment
- Failure of tack or participant's equipment
- Horse or rider accident or injury

Lane lines

When more than one course is in use, lane lines are required for safety. Courses are to be centered within each lane. At times, lane lines may not be used because of time constraints; however, the right to re-implement the lane lines requirement is reserved.

Run-out box

A run-out box may be used. The box size is generally 60 to 80 feet long, but it may be modified for safety or arena configuration. If a run-out box is used, all four of the horse's feet must remain inside the box until the judge's final acknowledgement.

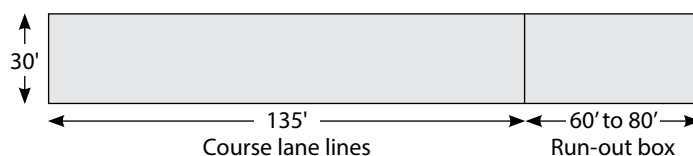

Moving a course

If a course is moved for safety reasons, riders may choose to re-ride or keep their first time. If the course is moved because of an initial wrong measurement, all riders must re-ride.

Acknowledging the judge

Riders **MUST** acknowledge the judge before starting and after completing the course. Protocol for acknowledging the judge is as follows:

- At the start, the rider must control the horse and wait for the judge's signal to begin.
- Before the exit, the rider must have the horse under control, be mounted, face the judge, and wait for the judge's signal to exit.

Arena safety

- During the running of any event, all arena gates must be closed.
- Contestants must enter the arena mounted in a controlled, safe manner, and may leave the arena only after the judge's final acknowledgment. After the judge's acknowledgment, the exhibitor may dismount, take the reins off the neck for safety, and exit.
- It is recommended that only one horse be in the arena at a time.
- Only contestants, ring crew, and officials are allowed in the arena.
- Horses that constitute a safety hazard may be disqualified.
- In all events, the ring crew may reset downed equipment or repair lines after a rider has completed the course.
- Riders must enter the arena without assistance from anyone other than one or more 4-H members who are also mounted.
- Raking will be done as needed, but must be consistent within each age division.

Coaching

Coaching as defined by show management and at the judge's discretion is not allowed. It is inappropriate for ring help, announcer, timers, etc., to coach, encourage, or comment to or about exhibitors on the course.

Course

- A white line should be used to mark lane lines, a run-out box, and the keyhole.
- Two poles or cones, 30 feet apart (60 feet apart in the case of barrels), designate the start–finish line. A horse must pass between these poles or cones at the start and finish of each event.
- Course measurement is made from the center of the poles, barrels, containers, or other arena equipment.
- Timers are placed on the start–finish line.

Penalties and general disqualifications

There will be a 5-second penalty for each stake, pole, barrel, or small container knocked down. Intentionally righting a pole or barrel is allowed with no penalty.

Disqualifications include the following:

- Failure to enter the arena mounted
- Entering the arena with the assistance of anyone other than another mounted 4-H member
- Failure to cross the start line within 60 seconds from the time the gate opens
- Upsetting the start–finish markers
- Crossing the start–finish line outside of the start–finish line markers
- Crossing the start–finish line (breaking the barrier) with any part of the horse or rider (outside of the customary start and finish)

- Run-outs
- Refusals (a balk is not considered a refusal if the horse finally finishes the course correctly)
- Leaving the course
- Dismounting at any time while on course
- Failure to follow the pattern for the event
- Passing any obstacle completely on the wrong side
- Circling any obstacle while on course, except flag races and other container events
- Failure to keep all four feet of the horse from crossing a lane line at the same time
- Failure to keep all four feet of the horse inside the run-out box
- A horse being unruly or out of control
- Spurring or striking the horse in front of the cinch
- Striking the horse with arena equipment
- Using rubber bands or anything else to anchor the rider to the horse or saddle
- Failure to acknowledge the judge before and after the run

Show management or the judge may disqualify a rider for unsportsmanlike conduct, profanity, unnecessary roughness, abusing the horse, or disorderly conduct of any kind. The judge may also disqualify an unmanageable horse for reasons of safety or the exhibitor's inability to handle or control it.

JUDGES' HAND SIGNALS

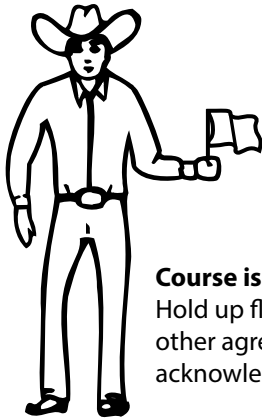

Course is ready:
Hold up flag or
other agreed-upon
acknowledgement

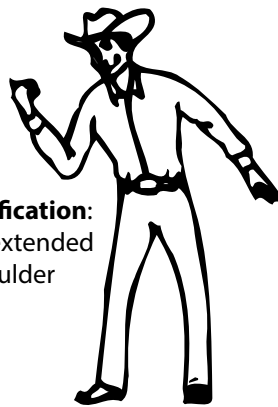

**General
disqualification:**
Thumb extended
over shoulder



**Failure to start
on time:** Point to
wristwatch

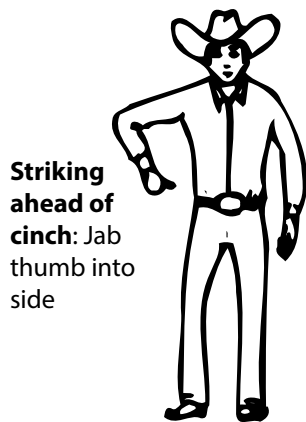

**Striking
ahead of
cinch:** Jab
thumb into
side

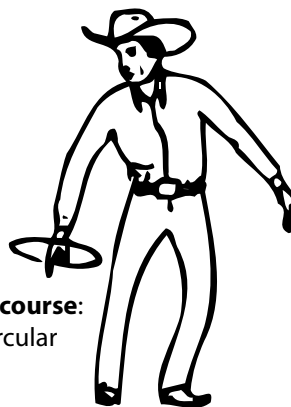

Leaving the course:
Horizontal circular
motion

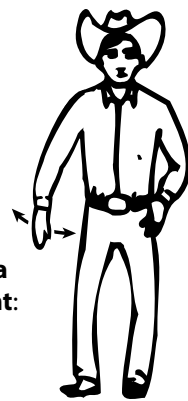

**Striking
the horse
with arena
equipment:**
Slap thigh

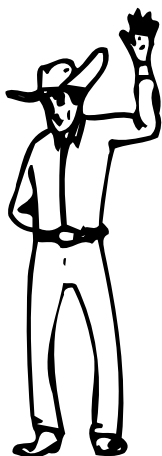

5-second penalty:
Hand raised
with five fingers
extended. Repeat
to show 10, 15, or
more seconds.

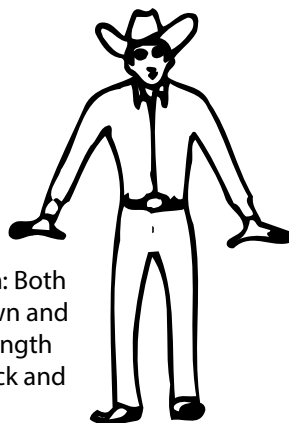

Safe or clean run: Both
hands, palms down
and extended arm's length
in front with a back and
forth motion

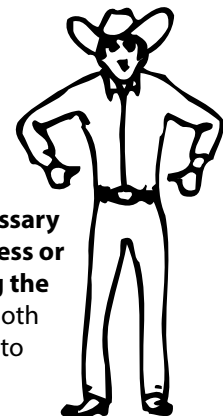

**Unnecessary
roughness or
abusing the
horse:** Both
thumbs to
the ribs

Approved Events

Figure 8 Stake Race

Two poles are set 120 feet apart at opposite ends of the course, and two center poles set 30 feet apart at a point halfway between the two end poles. The two center poles mark the start–finish line. The rider starts between the two center poles and runs a figure 8 around the two end poles, with the first turn being optional. Riders may start from either end of the course, but they may NOT turn a pole on the course before crossing the start line. There is a 5-second penalty for each pole knocked down.

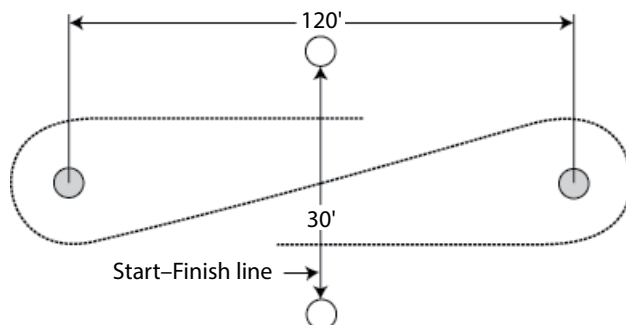

Idaho Figure 8

Two poles are set 100 feet apart, the first set 20 feet from the start–finish line; the second, 120 feet from the same line. The rider crosses the start line, rides down the side of the course (side optional) to pole B, turns pole B, rides to pole A, turns pole A in the opposite direction, rides back to pole B, turns pole B in the opposite direction of A, and rides across the finish line, completing a figure 8 pattern.

Riders must remain in designated lanes. There is a 5-second penalty for each pole knocked over. Turning a pole the wrong direction is considered off course.

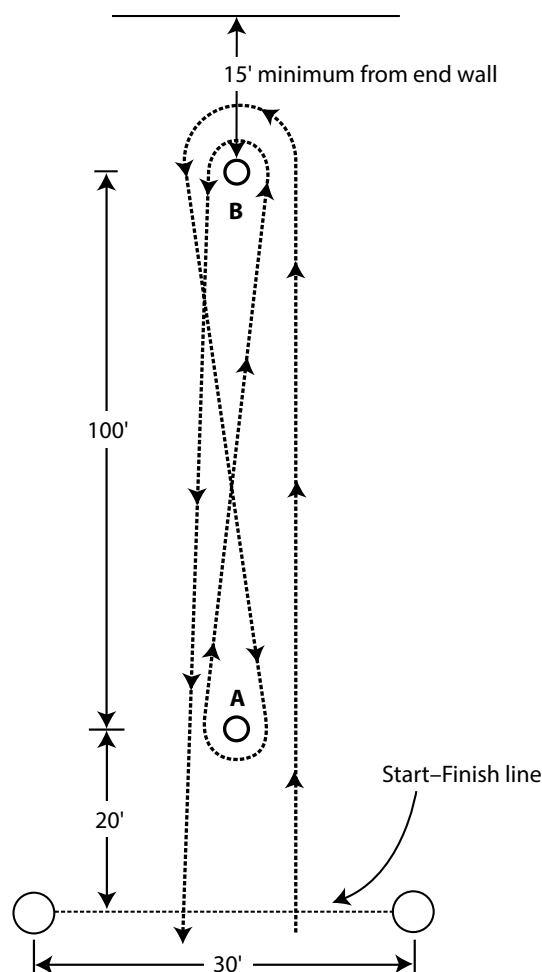

Pole Bending

Six poles are set in a straight line, each spaced 21 feet apart with the start–finish line 21 feet in front of the first pole. The rider crosses the start line, travels to pole number 6, turns, weaves back through the poles to number 1, turns, weaves back through the poles to number 6, turns and travels across the finish line.

There is a 5-second penalty for each pole knocked over. Poles will not be reset during the run. Riders must remain in their designated lanes.

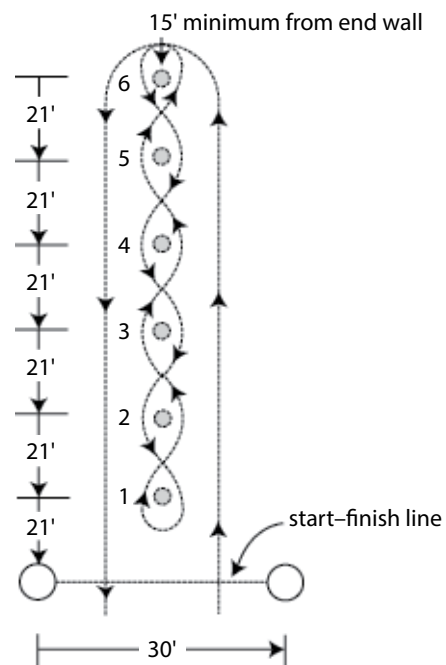

Key Race

Four white poles, striped or covered with a 48-inch red sleeve, are placed 5 feet apart at marks 110 and 120 feet from the start–finish line. The rider travels down, passing completely between both sets of poles (as diagramed), turns, reverses course back between both sets of poles, and crosses the finish line.

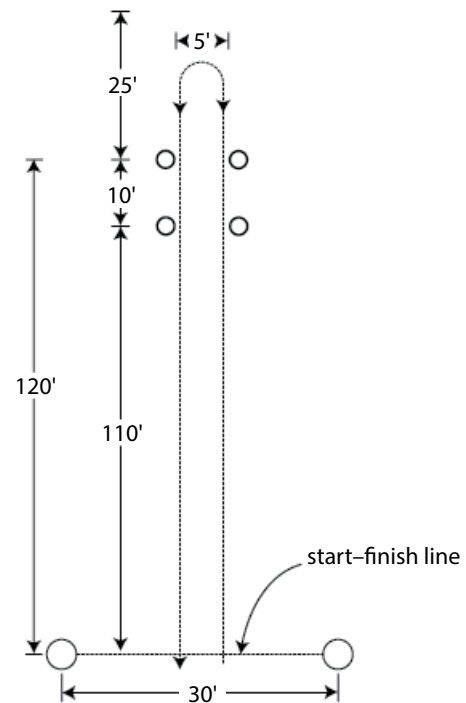

Barrels

Three barrels are placed in a triangular formation. For the 80-foot course, the No. 1 and No. 2 barrels are set 33 feet from the start–finish line and 60 feet apart. The No. 3 barrel is 80 feet from the No. 1 and No. 2 barrels. The 80-foot course can be used in all three states.

For the 75-foot course, the No. 1 and No. 2 barrels are set 30 feet from the start–finish line and 75 feet apart. The No. 3 barrel is 75 feet from the No. 1 and No. 2 barrels. The 75-foot course is used in Washington only.

Both courses use a 60-foot start line.

The rider crosses the start line, circles the No. 1 barrel to the right, crosses to the No. 2 barrel, circles it to the left, rides to the No. 3 barrel, circles it to the left, and travels across the finish line. The rider may alternatively cross the starting line to the No. 2 barrel, circle it to the left, cross to the No. 1 barrel, circle it to the right, run to the No. 3 barrel, circle it to the right, and proceed across the finish line.

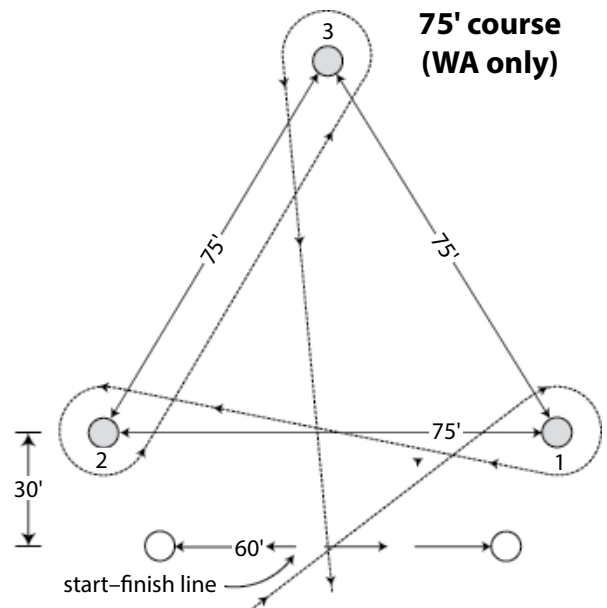
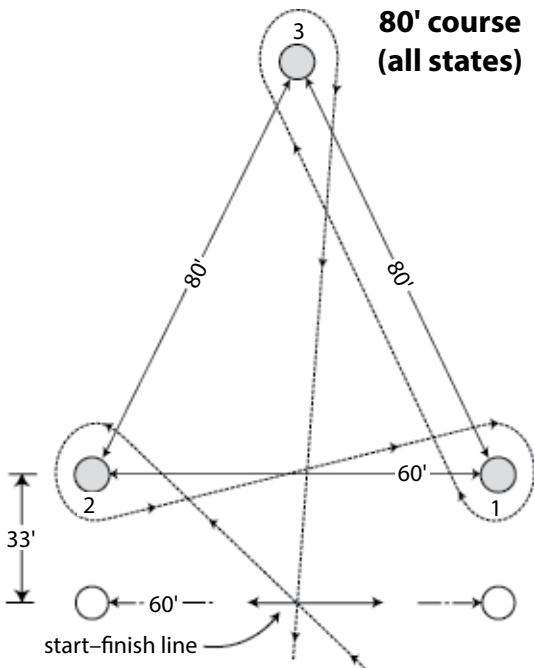

Keyhole Race

The rider crosses the start–finish line, travels 100 feet into a 20-foot-diameter keyhole marked with a white line, turns the horse, and returns across the start–finish line. All four of the horse’s feet must stay within the keyhole.

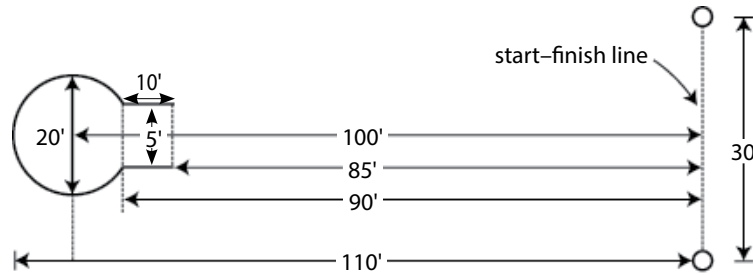

Two-Barrel Flag Race

Two metal quarter barrels (14 inches in diameter and 27 inches high) are set 100 feet apart, with the first barrel 20 feet from the start–finish line. The bottom of each barrel has 8 to 10 inches of sand or soft dirt. The two staffs should be wooden dowels of minimum 1-inch and maximum 1¼-inch diameter, 5 feet long, and painted white. Flags should be of sturdy cotton, hemmed to 8 by 12 inches, one white and one dark. Each flag should be wrapped completely around a staff and tacked securely, leaving an 8- by 8-inch portion free from the staff.

The rider crosses the start–finish line, rides to container A (side optional), and takes the flag; then, while riding around container B, the rider places the container A flag into container B and picks up the container B flag; the rider then puts the container B flag into container A as he or she passes; the rider finishes by crossing the start–finish line.

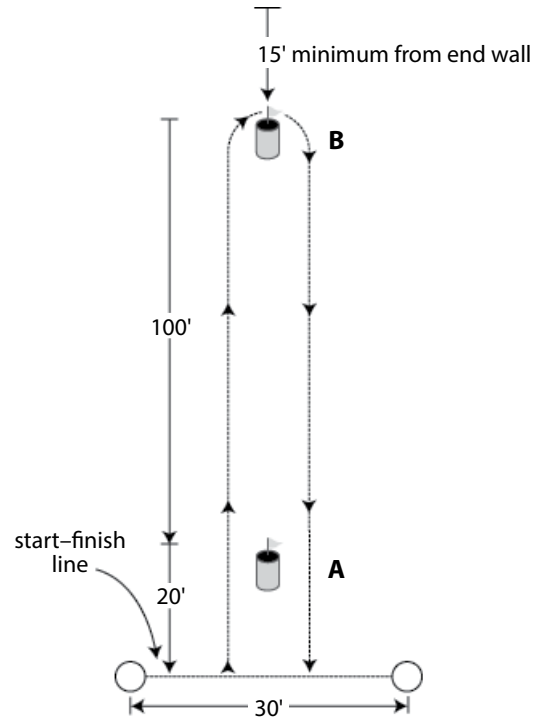

- Riders must designate the flag positions before starting the course.
- Riders may circle either barrel, if necessary.
- Riders may circle the barrel more than once, but there must be continuous forward motion.
- A 5-second penalty is added for each knock-down of a container, dropped flag, or missed container.
- A 10-second penalty is added for failure to pick up the flag from the barrel.
- If the rider carries the flag across the finish line, it is a disqualification.
- Riders may cross over between barrels B and A.

NSCA (International) Flag Race

A barrel is set 120 feet from the start–finish line. Centered on top of the barrel is a 3-pound coffee can filled $\frac{3}{4}$ full of sand or soil. A round dowel 14 inches long and a minimum of $\frac{7}{8}$ inch in diameter is placed in the can with a flag wrapped and tacked so that a 4-inch square is free.

The rider crosses the start–finish line, goes down and around the barrel in either direction, picks up the flag, and carries the flag back across the start–finish line. Knocking over the can is a 5-second penalty. Knocking over a can and barrel is a 10-second penalty. Dropping the flag before crossing the finish line is a disqualification.

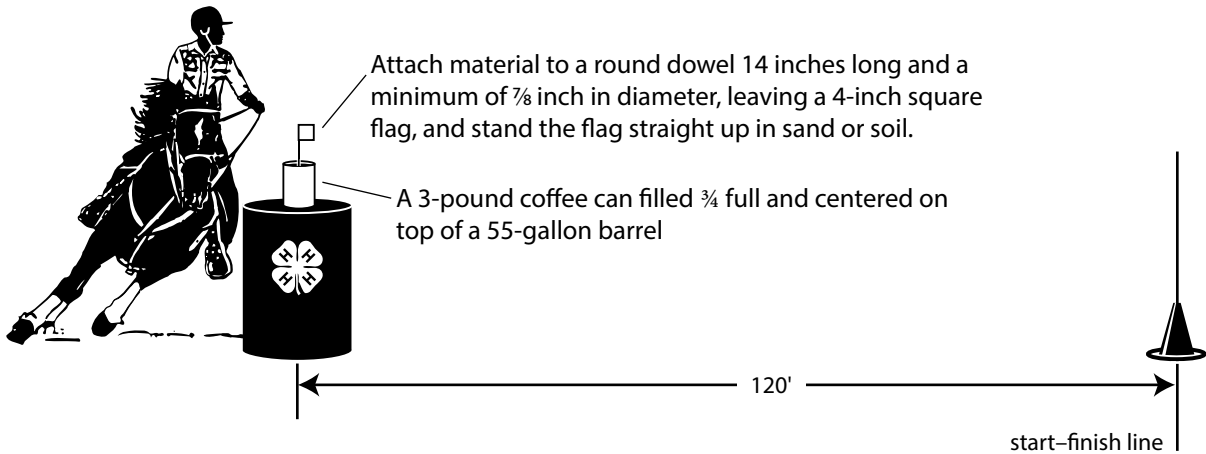

Front cover photo by Candi Bothum, Oregon State University Extension 4-H program coordinator, Deschutes County

© 2015 Oregon State University

Published and distributed in furtherance of the Acts of Congress of May 8 and June 30, 1914, by the Oregon State University Extension Service, Washington State University Extension, University of Idaho Extension, and the U.S. Department of Agriculture cooperating. The three participating Extension services offer educational programs, activities, and materials without discrimination based on age, color, disability, gender identity or expression, genetic information, marital status, national origin, race, religion, sex, sexual orientation, veteran's status, or because all or a part of an individual's income is derived from any public assistance program. The Oregon State University Extension Service, Washington State University Extension, and University of Idaho Extension are an AA/EOE/Veterans/Disabled.

Revised August 2009. Revised September 2015.